

THE MULTITEK CART



DISTINCTIVE FEATURES

- Ideal for transporting tools, original parts and spare parts
- Ergonomic working height
- Multiple layouts and configurations possible
- Choose from 20 colors to match your image
- Durable, reliable and unparalleled quality
- Made in North America

INCLUDES PROTECTIVE BUMPERS
ON ALL SIDES



THE MULTITEK CART

FITS SEAMLESSLY INTO YOUR WORK ENVIRONMENT

UNDER THE WORK SURFACE

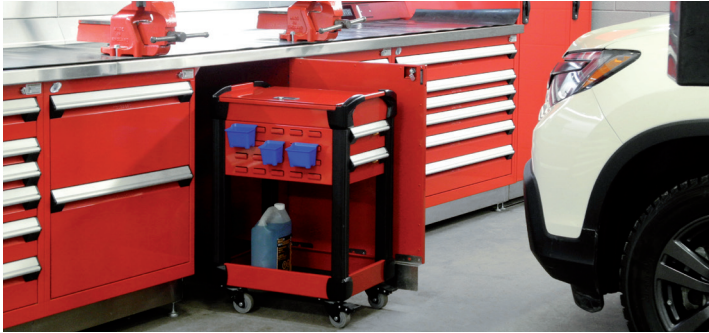

IN A STORAGE CABINET



NEXT TO THE WORK SURFACE



To perform vehicle repairs and maintenance, technicians need a variety of tools and parts near to the vehicle and within easy reach. With the MultiTek Cart, you can reduce the need to constantly go back and forth, and thus increase your efficiency. Every technician has their own way of working, and the requirements of each task can vary considerably between vehicles and between dealerships. The MultiTek Cart is therefore the perfect work companion because it can be personalized to suit your needs and working style.

THE HEAVY-DUTY AND VERSATILE MULTITEK CART WILL BECOME YOUR ESSENTIAL WORK COMPANION

The MultiTek Cart is fitted with soft PVC protective bumpers at the top and bottom corners. Vertical bumpers for the posts are also available as an optional add-on. Vehicles in the work environment will certainly be protected against any accidental impacts.

The base cart is the starting point for endless possibilities. Many configurations are possible, from a minimalist setup to fully equipped with all the accessories.

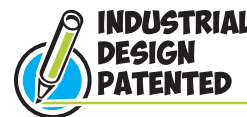

MULTIPLE CONFIGURATIONS

- In storage cabinets and under work surfaces
- Next to the work surface
- Standalone, like a caddy for transporting parts

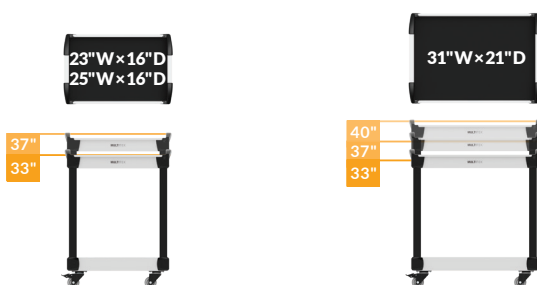

CARTS WITH 3\"/>

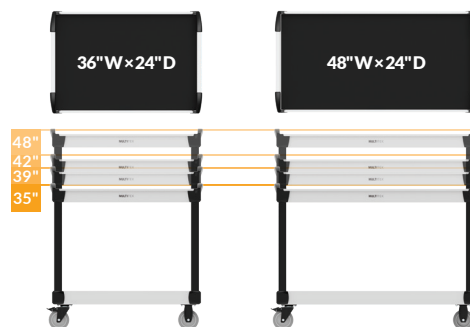

CARTS WITH 5\"/>

DESIGNED TO ACCOUNT FOR DIFFERENT WORK HABITS AND REQUIREMENTS

SPECIFICATIONS

Drawer: 50 lb.
 Shelf: 150 lb.
 Roll-out shelf: 15 lb.
 Cart: 600 lb.

4"* 23", 25", 31", 36", 48"** 16", 21", 24"** 33", 35", 37", 39", 40", 42", 48"**

* Usable height of drawers is 3". ** See bottom left "MULTIPLE CONFIGURATIONS" for available configurations.

LOCKABLE COVER

Opens 90° and pistons are strategically positioned to allow unrestricted access to the work surface



SOFT PVC PROTECTIVE HANDLES

The comfortable and ergonomic handles protect nearby vehicles from accidental impacts



BUMPERS

Soft PVC surfaces protect vehicles from bumps

Included

Optional



DRAWERS AND ROLL-OUT SHELVES

100% extension



PANELS

Utility panels or plastic bin panels



ACCESSORIES

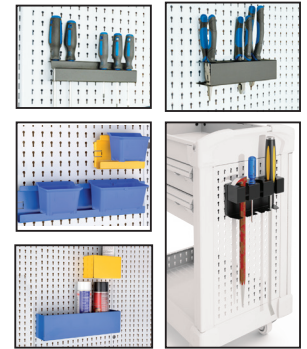

SUPERIOR QUALITY CASTERS

RUBBER MAT

DRAWER AND SHELF ACCESSORIES

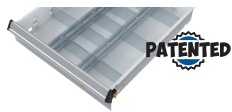

PATENTED

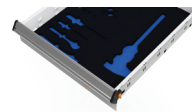
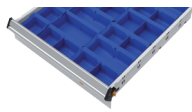

Partitions and dividers (Drawer)

Plastic bins (Drawer)

PVC drawer liner (Drawer and shelf)

Protective foam (Drawer and shelf)

Foam for tools (Drawer and shelf)

INTERMEDIATE SHELF



DID YOU KNOW?

One of Rousseau's biggest strengths is our wide range of color options. Choose from 20 standard colors.



Classic Blue	Avalanche Blue	Everest Blue	Midnight Blue	Glossy Sapphire Blue	Glossy EverGreen	Glossy Yellow	Sienna Orange	Flame Red	Glossy Carmine Red	Glossy Cranberry Red	White	Beige	Frost White	Light Gray	Modern Gray	Charcoal Gray	Glossy Black	Black	Glossy Carbon Black
052	055	051	057	560	1025	208	085	081	806	815	616	041	061	071	745	072	902	091	741

HERE ARE SOME SOLUTIONS

Go to rousseau-automotive.com for more suggested models.



25" x 16" x 33" RV-GB3300N101
31" x 21" x 37" RV-NH3700N101



25" x 16" x 33" RV-GB3300F101
31" x 21" x 37" RV-NH3700F101



25" x 16" x 33" RV-GB33A1F102B
31" x 21" x 37" RV-NH37A1F102B



25" x 16" x 33" RV-GB33A2F102B
31" x 21" x 37" RV-NH37A2F102B



25" x 16" x 33" RV-GB33A1UL10B
31" x 21" x 37" RV-NH37A1UL10B



25" x 16" x 33" RV-GB33A2UL12B
31" x 21" x 37" RV-NH37A2UL12B



25" x 16" x 33" RV-GB33A3X102B
31" x 21" x 37" RV-NH37A3X102B



25" x 16" x 33" RV-GB33S2F106B
31" x 21" x 37" RV-NH37S2F106B



36" x 24" x 42" RV-VM4200K106*
48" x 24" x 42" RV-ZM4200K106*



36" x 24" x 42" RV-VM4200K109*
48" x 24" x 42" RV-ZM4200K109*



36" x 24" x 42" RV-VM4200U106
48" x 24" x 42" RV-ZM4200U106



36" x 24" x 42" RV-VM4200U108
48" x 24" x 42" RV-ZM4200U108

For more information, contact our representative:

*Sold unassembled.

ROUSSEAU METAL INC.

105, AVENUE DE GASPÉ OUEST
SAINT-JEAN-PORT-JOLI (QUÉBEC)
G0R 3G0 CANADA

WEBSITE
rousseau-automotive.com

END USERS
1.866.463.4270
EMAIL
info@rousseau.com

DISTRIBUTORS
1.800.463.4271
DISTRIBUTORS ACCESS
e-rousseau.com



7PV11A00
V11-FE20A